

of the colour of glowing embers, which was stationary in the air, at a height of about two metres from the floor and half a metre from the ceiling. She felt that the object was "observing" her. She describes it as about five centimetres long and three centimetres thick. She detected no sound from it, nor smell, nor any sensation of heat or cold. Her first impression was one of mere surprise, but as she stood there and watched the object, still motionless, she became scared. After a few minutes, she retreated into her bedroom and spent an anxious and sleepless night fearing that it would come in, but it did not, and when she got up next morning, the object was gone. After much hesitation, she decided not to tell her parents, since they "would perhaps not have believed me, or

would have laughed at me." The only person whom she told about it was her older sister Inés, but her brother only chanced to hear about it long afterwards — in 1980.

A very similar sort of thing, seen in a house in Rio de Janeiro, Brazil, was reported by Dr W. Buhler in 1962, and Jennie Zeidman has given us another case, with almost identical features, from Ohio, U.S.A., in 1979.

NOTES AND REFERENCES

- (1) Jennie Zeidman: *The Thing that Got into the House*. In FSR 28/2 (1982), page 9.
- (2) Dr W. Buhler: *A Similar Case in Brazil in 1962?* In FSR 28/2 (1982), page 10.

CLOSE ENCOUNTER AT PRATO DI PRINCIPATO ULTRA (ITALY), OCTOBER 1984

Umberto Telarico

(Translation from French)

In FSR30/4 we gave a brief, fifteen-line account of this case, in Signor Edoardo Russo's *Italian Update 1984*. Edoardo Russo is the Foreign Liaison Editor for C.U.N., the Italian National Ufological Centre. The March/April 1986 issue of *Lumières Dans La Nuit* (No. 261/262), which we have recently received, contains a long and most detailed account of this case, written originally by Umberto Telarico and rendered into French by Maria Toffano. The material published in FSR is always at the disposal of our good friends in France and Italy and, on the same basis, we take the liberty now of translating Maria Toffano's French version into English for our readers.

The date of the episode was October 8, 1984. As will be seen, there are certain discrepancies in the two versions. We can, however, take it as certain that this later and very thorough investigation has provided the accurate story.

Our thanks and congratulations to CUN in Italy and Jacques Scornaux and to LDLN in France for this most interesting piece of work, and also to a second Italian group, the "SOLARIS" UFO Investigation Group in Naples, who conducted their own supplementary enquiry. The case occurred in a country area north-east of Naples in Southern Italy. — EDITOR

PARTICIPANTS: Q: CUN Investigator Umberto Telarico
A: Eyewitness of episode, Giuseppe Coccozza
C: Accompanying CUN Investigators

* * * * *

Q: Well now, Don Peppino. Just pretend that there's nobody else here in this room with us. It is the morning of October 8 of this year, and you are going out to your alfalfa (lucerne) field. Recall in a loud, clear voice what happened.

A: This is what happened. I had been alone in the

house, as my wife and my son had gone to the funeral of my mother-in-law. I didn't go with them myself as I had a very painful leg, due to arthritis. So I decided to go and get some fodder for my cow, which was in the byre. While I was getting the lucerne, I suddenly noticed a man — an individual — who seemed to be a stranger. I stood looking at him for a bit, and thinking, for I had never seen anybody who looked like that. And then, as I looked at him, I said to myself: why, this chap's a madman. Just look — what a madman!

I had a side-view of him. Then I had the idea of coughing, so as to get him to turn round. When he heard me cough, the man turned round

towards me and then I saw that he had a pair of a sort of aluminium spectacles in front of his eyes.

- Q: What was his height?
A: About 1 metre 20, or 1 metre 30.
Q: What distance was he from you?
A: About 20 metres.
Q: But what was he doing?
A: In his hand he was holding a little forked rod, with two teeth, and exploring the ground, swinging this little fork. When he heard me cough, he turned round and looked at me for a few seconds. He took three or four steps, and then began to give off sparks from both sides, like from an electric welder, and from the other side he shot out flames, and me, well, when I saw that fire I got scared, and I stepped backwards, I retreated, very softly. Two minutes later, as I was stepping back, I saw a box take off, very fast. It travelled three or four hundred metres in a second, going absolutely straight. Then it landed on the ground again, further on, beyond a wood.
- Q: And approximately how big was this "box"?
A: It could have been about two metres long, shall we say, and one metre thirty, or one metre forty cms. wide.
- Q: Was there anything strange about the thing, or was it a normal "box"?
A: No. On top of the box, I noticed that there was what seemed to be like a sort of dish, with two supports holding it.
- Q: Did you hear any noise, any sounds?
A: No, I heard nothing. The only sound I heard was from *him* when he gave out the sparks and made the sound like "tra-tra-tra".
- Q: Now, let us discuss this individual, that you saw. You have said that he had a round head, like us. Was it larger than ours?
A: It was like our head. But it isn't certain that it *was* a head.
- Q: Did he have a neck?
A: Yes.
- Q: Was his body thick-set?
A: Yes. He was very strongly built, but of small height: one metre twenty centimetres, or one metre thirty...
- Q: Did you notice any limbs, like arms, legs?
A: Oh yes, arms and legs. He was bending over while he was doing that. (*Note by Author: the entity raised one leg, and then the other, several times, and bending the knees, as he manipulated his instrument.*)
- Q: Was the length of his arms normal in relation to his height?
A: Yes.
- Q: Did you notice whether he had fingers like ours, or whether they were different?
A: I didn't see them. He had the forked rod in his hand. It was of the same colour. (*Note by Author:*

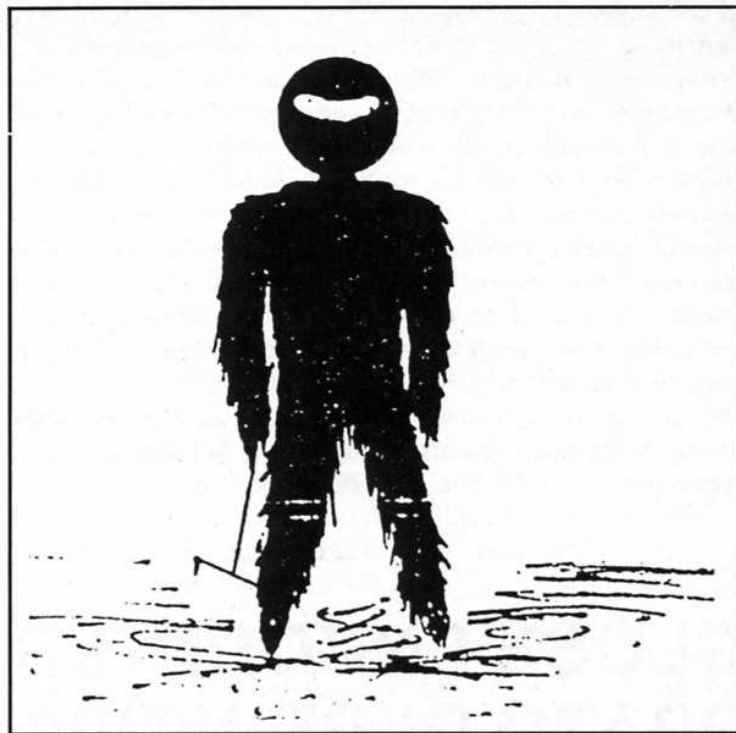

Fig. 1 Frontal view of the entity, holding his forked rod.

- of the same colour as his body, which was of a dark hue, covered with long hair.)
- C: Was he holding it by one hand only?
A: In one hand at first, while he was doing that. After that, I coughed...
- Q: What did you notice that he had on his back?
A: On his back he had a sort of box from which a lead ran to the nape of his neck.
- Q: And were there other tubes?
A: Yes, there was another lead there (*indicates the spot on a sketch drawn by the Investigator*) which also went across his back under the box. Then it seems to me that here (*he indicates the protuberance on the site of the mouth*) there was a small tube that was attached to his back, somewhere near the box.
- Q: You saw him from the back...
A: Yes, I saw it when he turned round.
- Q: What was the box like? Was it made in one piece?
A: Yes.
- Q: Did it have angles, or was it round?
A: It was square.
- Q: Like a rucksack?
A: Yes — that's it. Like a rucksack.
- Q: And, tell us, Don Peppino, what did he have on the front of him?
A: In front, all I saw was that he was hairy, like a goat.
- Q: Was the hair long?
A: Yes — long. About 15 cms. long.
- Q: Over the whole body?
A: Yes, yes. Down to here (*indicating the feet*). And

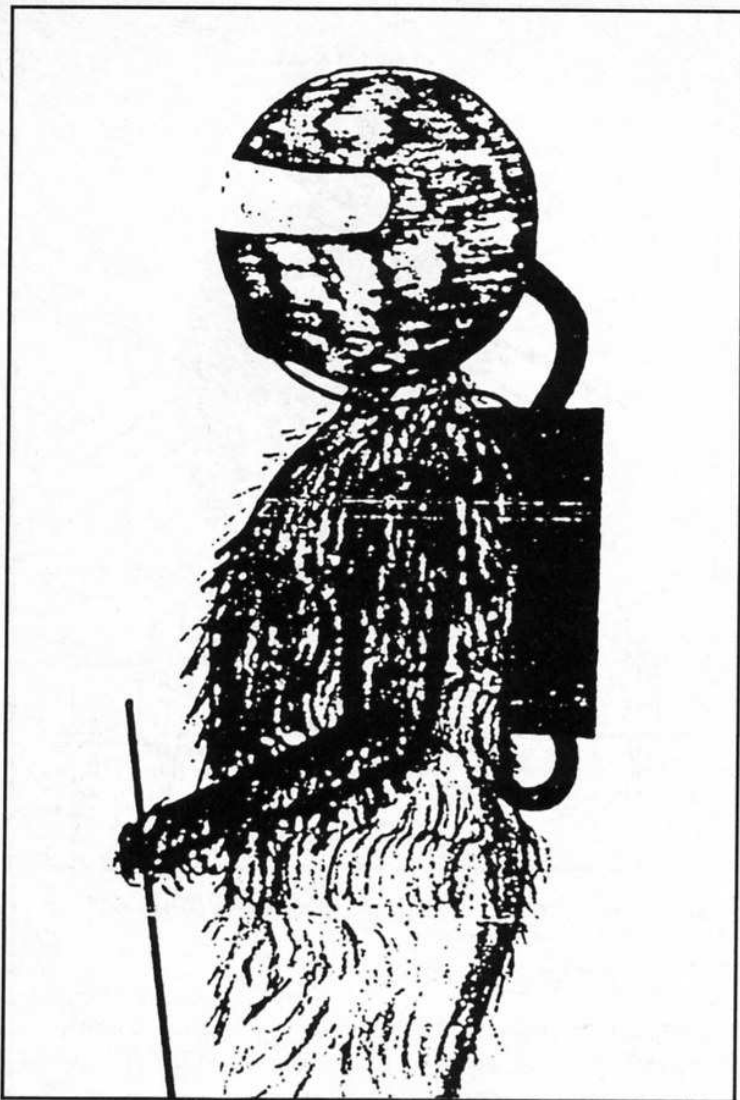

Fig. 2 Profile view of the entity, showing position of a possible small tube between the mouth and the pack on the back.

there he had hooves, like the hooves of a donkey or a goat.

Q: What did he have in front of his face?

A: In front of his eyes I saw spectacles with a visor of, how should I put it — a sort of aluminium crystal.

Q: Of what shape was it?

A: It went right across to the ears (*indicating on his own face*).

(The Investigator at this point shows him a sketch of the entity's "helmet" and the witness sketches roughly on it the shape of the "spectacles".)

Q: Of what colour was his "head"?

A: Still all the same colour ... dark brown.

Q: And what was it, Don Peppino, that came out from the sides of the pack on his back?

A: No. It was from the chap's sides. He gave out flashes of the same colour as from a soldering-iron.

Q: Did the flames come out irregularly?

A: No. It was continuous. He shot out flames without stopping.

Q: However, he wasn't emitting flames when you first saw him?

A: No. But I'm just telling you what I saw.

Q: So, when he turned round and saw you...

A: I coughed, and the chap turned round. I watched him for a moment, and then he took two or three steps backward and began to make this "zrou, zrou, zrou" sound, shooting out flames from both sides.

Q: Did he turn round because he was about to depart?

A: Yes. He turned towards me, and he saw me...

Q: And he started to shoot out flames from his sides. Were the flames very long?

A: Maybe not as much as a metre, but at least 70-80 cms. of flame, shooting out on the right and left sides of him.

Q: Flames of what colour?

A: Of exactly the same colour as when you use a soldering-iron ... violet-coloured, like you get in arc-welding with oxygen.

C: Are you sure the flames did not come from the pack on his back?

A: No. No. From his two sides (*indicates his own haunches*).

C: Were there tubes, or holes, there?

A: Ah, well, that — I didn't notice that...

C: But they came in bursts, like this...

A: Yes, in bursts. "*Foumm, foumm, foumm*" ... And then, after that, "*zrou, zrou, zrou, zrou, zrou*". That was the noise

C: And his feet?

A: Maybe of aluminium ... I don't know...

C: And the flames ... were they continuous?

A: Continuous all the time ... fixed, no fire, just these jets.

C: Maybe it was just *light*, and you had the impression that it was flame?

A: No. There were sparks.

Q: When he saw you, he didn't start to run?

A: No. He walked fast, but with short steps...

Q: He never turned back towards you?

A: I watched him, right up to that moment, but once he had passed behind the tree, I lost sight of him ... and I tried to see him ... and then I saw this sort of box taking off.

C: How did he walk, how did he move?

A: Just like a normal person ... but he was too ... his steps were too fast, but short, not the way people would walk.

C: Should we say — like a child?

A: Well, yes, that's right...

C: His gait was in proportion to his height, would you say?

A: He walked quickly, but his steps were small because he was small himself ... he didn't have legs like us ... you see what I mean?

Q: And while he was holding this instrument, he was bending his knees?

A: Yes.

Q: Then, after that, what happened, Don Peppino?

AL: Well then, after that, I saw this sort of box taking off. In one second, it was behind the wood, and after that I saw nothing more.

Q: So, what did you do after that?

A: I went back home, and I got my gun, and I put some cartridges in. I took out the small cartridges and put some big ones in instead. And then I went back there. Showing myself as little as possible. So as to see more or less whether ... I returned more or less to the spot where it had happened. I found footprints on the ground. No, not footprints, but rather, a sort of hoof-marks ... so queer, I didn't know whether it was from a horse, a horseshoe ... or ... anyway, in brief, truly very queer little hoof-marks. Then, having in the meantime pushed on a bit further, I saw this outline there on the ground (the marks left by the UFO) as though something had landed there. I couldn't understand what it could be ... I'd seen that flying box that had landed there, but me, well, I couldn't make out what that was ...

Q: So then what did you do next?

A: What did I do? Well, I returned home. There was nobody in the house. When my son Michele returned, I sent him over to see the Carabinieri (Police) at Pratola Serra. But by the evening, nobody had come, so I sent another of my sons over to them and told him to say to them: "Come ... because I know what I have seen ... And, if you don't, I will go somewhere else. And if tomorrow something serious happens ..." Well anyway, the Carabinieri did come that evening, and they even went out to the spot. And then they came again the next day — I think it was the Lieutenant of Carabinieri. And other people came. The Italian Air Force. And also some experts, I don't

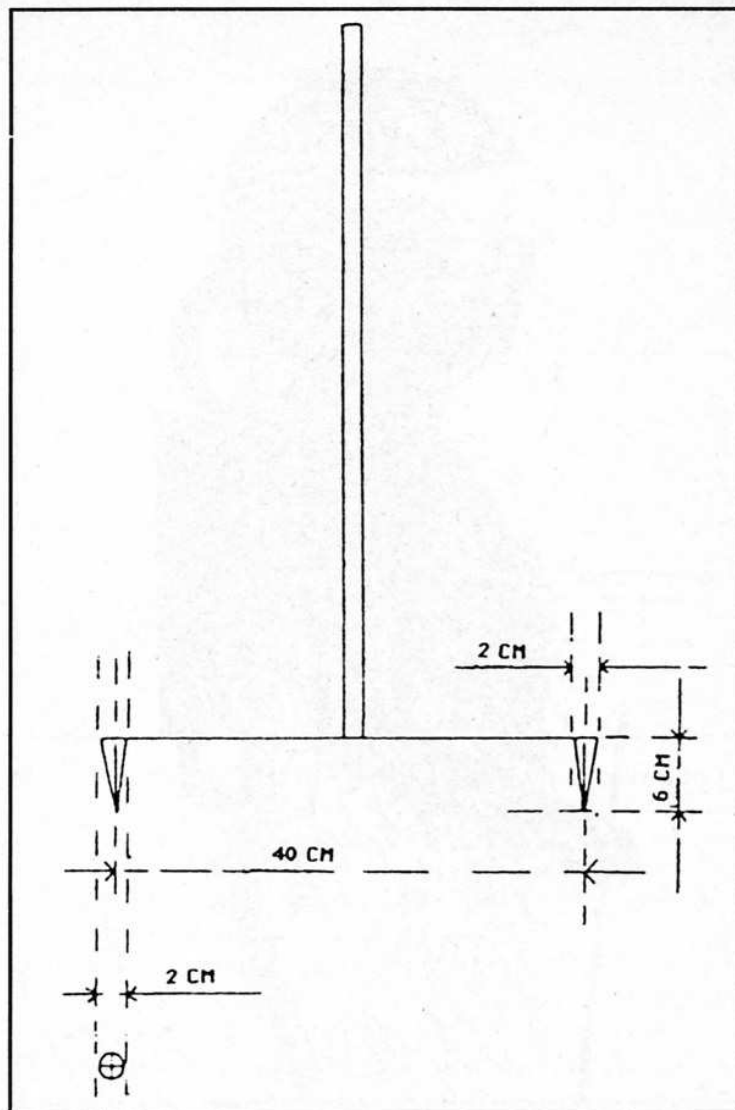

Fig. 3 The forked rod.

know exactly who. That's all I saw.

Q: Thanks, Don Peppino!

(Tape-recorded interview, transcribed by Umberto Telarico.)

A RECONSTITUTION OF THE FACTS OF THE CASE

ON the morning of Monday, October 8, 1984, Signor Giuseppe Coccozza, a 57-year-old Italian farmer, was alone in his house, his wife and son having gone to the funeral of a relative.

At about 7.30 a.m., Signor Giuseppe decided to go to his field of alfalfa (lucerne), distance some 350 metres from the house, to get some fodder for his cow. He walks slowly — for he has arthritis in one leg — along a beaten-earth path flanking the limits of his property. At about 7.40 a.m., just after a bend in the path, he halts, for, ahead of him, and on the path, about twenty metres distant, he perceives an indi-

vidual of unusual appearance. (Fig. 1.) He is about 1 metre 20 cms. in height, is wearing something resembling a helmet on his head, round and of a dark colour. On his back he is carrying a rucksack — or box, about 30 cms. by 30 cms. in size, and of the same colour as the helmet; from the upper part of this rucksack or box a sort of tube runs up and joins the helmet at the nape of the neck. A second tube emerges from the lower side and seems to pass between the rucksack and the back of the entity.

The eyewitness estimates that the diameter of this "tube" was a little larger than the thickness of a finger

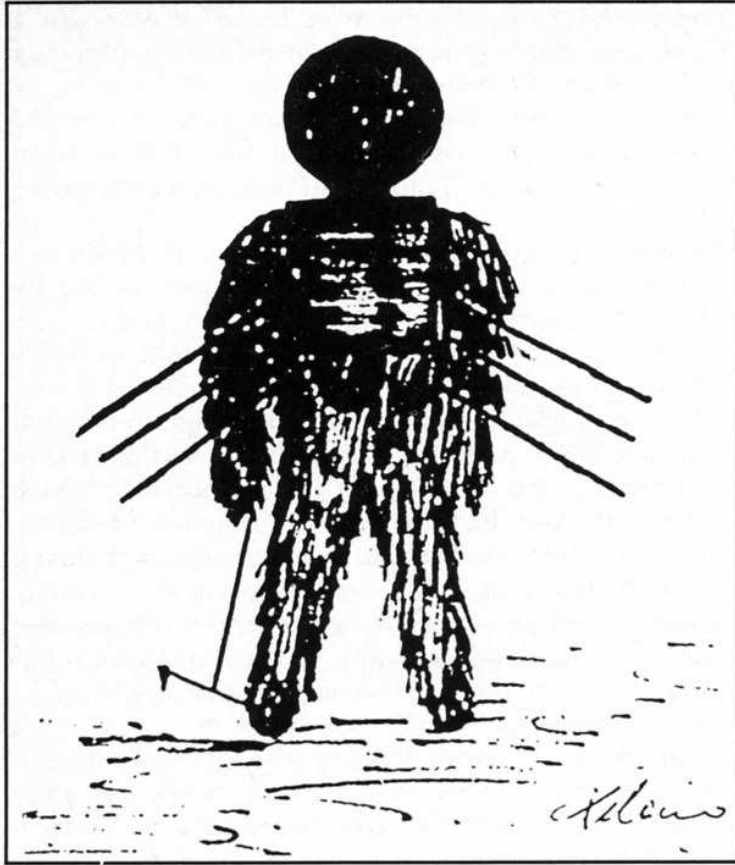

Fig. 4. The entity departs, emitting flames from his flanks.

(i.e. about 2 cms.). He also had the impression that there was a finer tube between the bulge observed at the place where the mouth would be and the upper side of the rucksack. However, this is not quite certain. (Fig. 2.) The rest of the body of the entity appears to be covered with a sort of hair (like that of a goat, according to the witness), of a dark brown colour, with long hairs some 10 cms. to 15 cms. in length. This personage appears to be engaged in exploring the ground with the aid of an instrument. This instrument is shaped like a reversed "T" with two points penetrating into the ground. (See Fig. 3.) Furthermore, Signor Coccozza observes that, as the individual is performing this "work", he raises his legs alternately, several times, as though intent on not getting too deeply embedded in the soil on the path, which is fairly soft and muddy due to stagnant puddles of water.

The eyewitness is greatly disturbed and alarmed by the presence of this stranger whom we have just described. His first thought is that it is a "madman in disguise". A few moments later, he tries to provoke some sort of reaction on the part of the individual: he coughs, hoping that his presence will induce the personage to depart. The latter, hearing the cough, halts and faces round towards Signor Coccozza, showing a sort of wide slit at the level of the eyes, of a bright aluminium colour. Then, a few moments later, he turns his back on the farmer and departs in the direction of a clearing among the hazel-bushes. As he walks, he

emits from both sides of him small bluish flames (like those of a blow-lamp) some 60-70 cms. in length. (See Fig. 4.) The emission of these flames is continuous and accompanied by a rhythmic sound (resembling the sound of an electrical apparatus). The witness, frightened, retreats and loses sight of the entity, which, after covering a distance of a few metres, vanishes behind a hazel-bush. About a minute later, Signor Giuseppe observes a strange flying object which rises into the sky following an inclined trajectory. The UFO appears to have taken off from the clump of hazel-bushes some 70 metres or so from the witness. In the space of a few seconds the strange craft climbs to 500 or 600 metres. Then, abruptly, it performs an acute-angled turn and heads towards the mountain range, seemingly towards the foot of them, as though with the intention of landing again. (Fig. 5.)

The witness describes the UFO as like a parallelepiped, or a "box" or "case" as he himself calls it, surmounted by a sort of "dish" supported by two tubular structures. (Fig. 6.) The flying object appeared to be of a dark brown colour. It emitted no perceptible sound or light. It is however to be noted that had there been any sound, if not very loud, it would have been blotted out by the noise of the river Sabato, flowing some 20 metres below the path, and only a few metres distant.

Signor Coccozza returns home, gets his shot-gun, and returns to the spot. Then he perceives numerous strange imprints like those of a long hoof (these are the marks left by the entity) and a number of holes spaced at regular intervals (these being the marks left by the rod carried by the entity). The witness follows up these traces as far as a clearing among the hazel-bushes, where he observes other marks, very clearly imprinted, which he connects with the presence of the flying object. Then he returns home again and awaits the arrival of his wife and his son Michele.

After the arrival of his family, he sends his son to the Carabinieri Station at Pratola Serra, to ask them to come. That same evening, the Carabinieri not having arrived, he sends a second son to request their help. Finally the Carabinieri do arrive and, after hearing Signor Coccozza's account, they go to inspect the marks (using electric torches). They return next morning with the Commanding Officer of Carabinieri at Mirabella Eclano, Signor G.S.F. Carrarelli, who takes charge of the necessary operations, namely preparation of a plan of the landing-site, detailed sketches of the trace-marks, plaster-moulds of same, and samples of soil and vegetation. That same day, the Carabinieri took Signor Giuseppe Coccozza to the Station at Pratola, where he signed a statement concerning the facts set out above.

Evaluation of the Case

The sole witness in this case, Signor Giuseppe Coccozza, a working farmer, is an individual who still

has all his physical and mental faculties, despite an operation for the removal of his gall-bladder eight months ago and arthritis in one leg. He appears to be a good observer, not at all emotional, who is difficult to impress, and mentally well balanced. (Incidentally, the operation undergone by him means that he is unable to drink alcohol.)

The description of the entity given by him is especially detailed, for, thinking he was dealing with a "disguised madman", he was not afraid, as is so generally the case when people experience phenomena of this kind.

As he has no electricity in his house, and the cost of having it laid on would be relatively high, Signor Cocozza possesses neither radio nor television. On the rare occasions when he has encountered talk of UFOs, it has been in the pages of the local weekly paper, *La Cronaca Vera*. In any case, he has always said he was sceptical on the matter of UFOs. This circumstance, together with his extremely modest cultural level, shows us that his story has not been influenced by any external factor, such as books, magazines, television, radio, etc.

Consequently, in our view there is nothing that might raise any doubts as to the credibility and good faith of Signor Giuseppe Cocozza

The Carabinieri from the Stations at Pratola Serra and Mirabella have expressed a similar view to this in their respective reports.

Should one desire at all costs to explain the UFO phenomenon at Prato di Principato Ultra in terms of the known, then the sole possible hypothesis is premeditated hoax, perpetrated by parties unknown, for

some equally unknown motive. In any case, such a hypothetical explanation could furnish no convincing answers to the following questions:—

1. Why choose to land at a distance of only a few metres from the trees, when it would have been more "normal" to land in the middle of the clearing?
2. Anyone organizing a "joke" of this sort would not have chosen so inaccessible a spot, half-hidden by trees. Furthermore, he would not have chosen to do it at a time of the day when people would so rarely be met, especially at that time of the year.
3. A very careful analysis of the marks apparently left by the UFO, and the irregularities in the terrain where they are, reveal that the supports on which the craft stood had not only the function of underpinning the craft but also the function of ensuring a well determined position vis-a-vis the ground, thus cancelling out the irregularities in the terrain.* The unknown perpetrators of the "joke" would in that case have included an aeronautical engineer.
4. What technique would have been required to lift (silently) a big parallelepiped (the UFO) to a height of 500-600 metres above the ground and then cause it to perform a right-angled turn and vanish over the mountains?
5. The "joke" would also have required the participation of a child in disguise (the entity). How long would the child have been able to keep the secret and not reveal the identities of the organizers of the prank?

Would it not have been "safer" to "disguise" an adult?

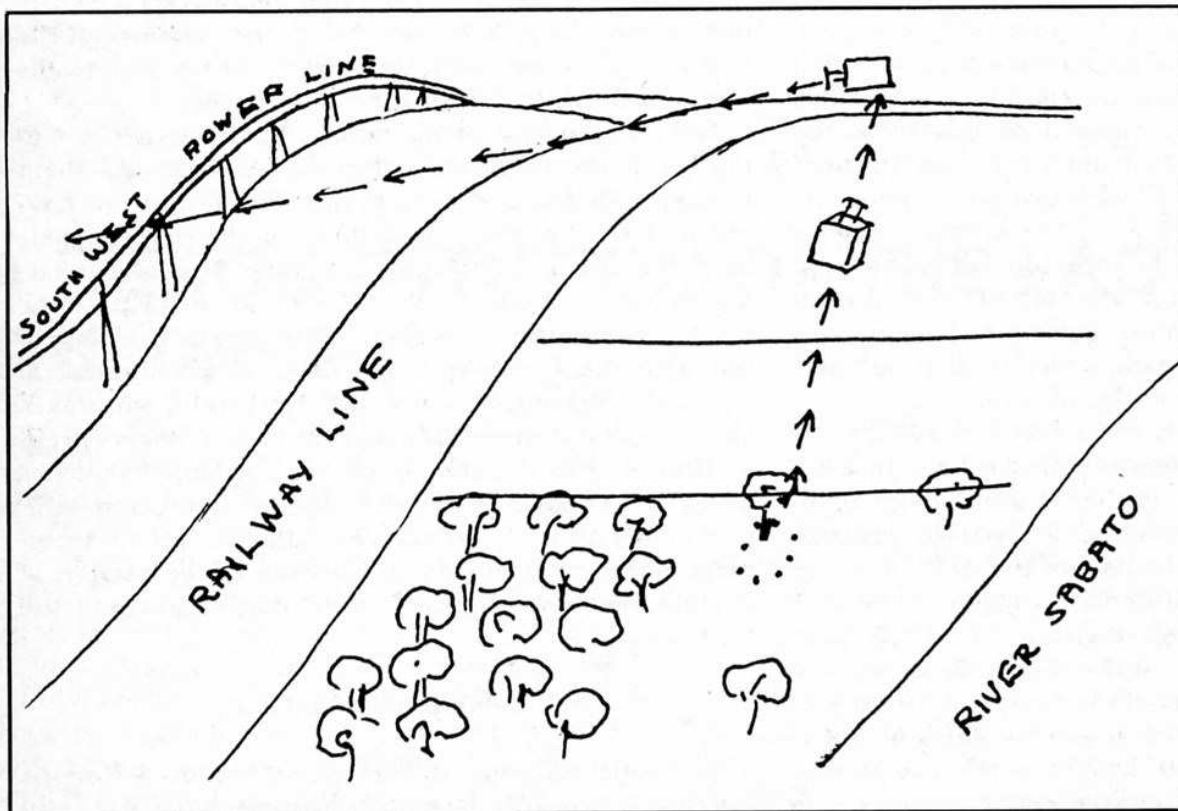

Fig. 5. The departure flight of the UFO.

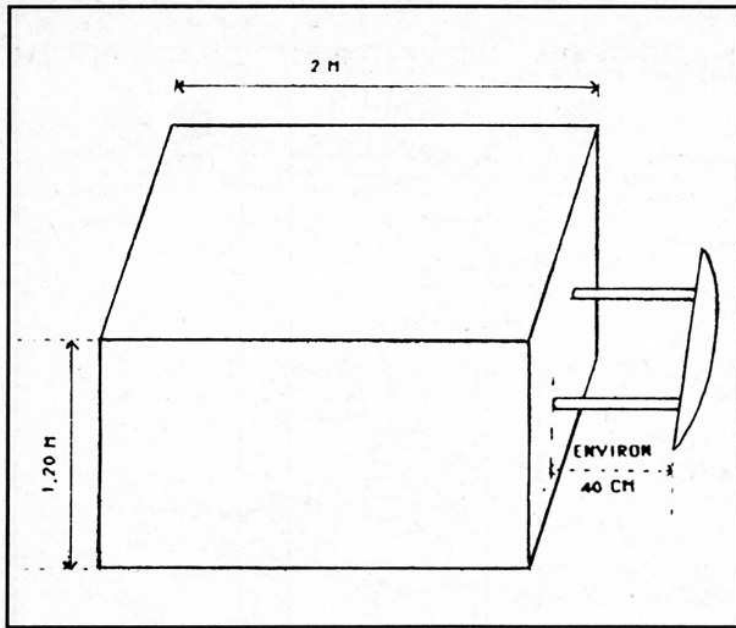

Fig. 6. The UFO, its size being estimated on the basis of the trace-marks.

Conclusions

There is then no reason to doubt the credibility of the testimony furnished by Signor Giuseppe Cocozza concerning this UFO phenomenon at Prato di Principato Ultra. This certitude is due not only to the objective verification of the greater part of the facts (which we are able to reconstitute thanks to the trace-marks left on the ground) but also due to the fact that, possessing neither a radio nor a television, the witness cannot have been influenced by Science-Fiction programmes.

There is consequently at present no reason for doubting that the events as related by the witness did in fact occur as he states. Furthermore, there is no indication whatsoever that might suggest a possible fraud.

Consequently our opinion, as investigators, is that a physical phenomenon of an unknown nature did indeed occur at Lapazzita (Commune of Prato di Principato Ultra) on October 8, 1984, and that it is at present not possible to explain it in habitual terminology. — Umberto Telarico

Analyses of Trace-Marks on the Ground

Radioactivity

Small quantities of soil and vegetation taken from the site of the presumed landing were tested with a Gamma-type radiation-detector of A.N.S.R. type manufactured by Abbotts.

These samples consisted of soil from outside the perimeter of the trace-marks (SAMPLE A); soil from inside the perimeter of the trace-marks (SAMPLE B);

and blades of grass from within the perimeter (SAMPLE C). The detector was adjusted for an energy field of between 15 and 70 Kilowatts, and the measurements — in counts per minute (CPM) — were taken twice.

The values obtained reached a maximum of 15 CPM for Sample B and a minimum of 2 CPM for Sample C. On the basis of this, the biologist who effected these tests, Mme Wanda Utech, concluded that, so far as the samples analyzed were concerned, any Gamma ray contamination could be ruled out, inasmuch as the minimal value when one is talking of contamination is 30 CPM.

A supplementary check effected with a Geiger Counter (for Gamma-type radiations) also yielded a negative result. This did not, however, rule out the possibility of contamination of the samples examined due to radiation of other than Gamma-type.

Number, Shapes, and Sizes of Trace-Marks

A. TRACES LEFT BY THE HUMANOID (Text extracted from the Report of the investigation by the Solaris Research Centre.)

1) The imprints found at the place where the witness saw the humanoid were scattered in a confused fashion within a 30-metre periphery. Starting from the tree situated near the path, they terminate at the spot where the "box" is presumed to have taken off.

These traces of the first type can be described as follows: an inverted cone with the point downwards, 12 cms. in diameter and 7 cms. deep. These marks were found especially at the spot where, according to the witness, the humanoid was "sounding" the soil.

2) A second type of trace-mark can be described as follows:— comparing it with the

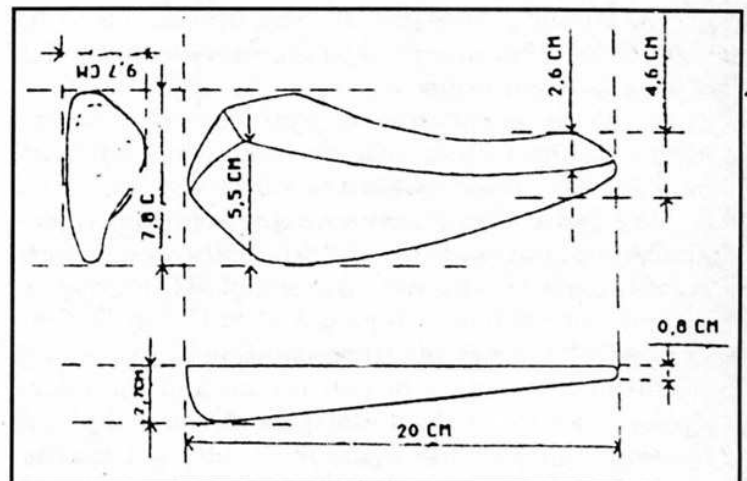

Fig. 7. Plaster-cast imprint of entity's right foot, at a spot 7m. from the landing site of the UFO.

imprint left by a human foot, we could say that, in place of the heel we find a groove resembling the hole made by a shoe-heel 2 cms. thick, and in the place of the sole of the foot, we observe two parallel plates. The total length is 20 cms. and the width 8 cms., and the depth certainly less than 2-3 cms. (See Fig.7.)

B. TRACES LEFT BY THE UFO (at a spot 35 m. to the north-west of the place where the witness saw the humanoid). (See Fig. 8.)

- 1) Two elliptical marks, 2.3 metres apart (See Nos. 4 and 8 on Fig. 8) and with the following dimensions: major axis: 20 cms.; minor axis: 10 cms.; depth: 8 cms.; surface: 191 cm². According to the investigation by the Solaris Centre, the "floors" of these two elliptical marks showed a series of grooves parallel to the minor axis.
- 2) Six roughly cylindrical holes terminating at the bottom in truncated cones, and disposed as shown in Fig. 8 (numbers 1, 2, 3, 5, 6, and 7). Their dimensions were as follows: maximum diameter (at surface): 9 cms.; minimum diameter (at bottom): 4.5 cms.; depth of the cylindrical portion: 2 cms.; depth of the truncated cone portion: 7 cms.; (thus giving a total depth of 9 cms., whereas the Solaris Centre gave them a depth of 20 cms. — could this difference be due to the deterioration in the condition of the marks during the time between the visits of the two parties of investigators?) The Solaris Centre's report also adds the detail that one of these holes looked as though it indicated the thread of a screw; total surface-area of six holes at ground-level: 63.5 cms².
- 3) The Solaris Research Centre alone mentions the existence of two parallel furrows, 2.30 m. long, 15 cms. wide, and 2 cms. deep, running from one of the elliptical marks to the other and flanked on the outside by the six conical holes.

With commendable caution, the Solaris Centre's report has the following comment on the trace-marks as a whole:

"We feel it is our duty to express certain reservations as regards the validity of the description of the marks, and notably as regards the shapes and dimensions of the conical holes; in fact, in view of the bad weather conditions prevailing during those days in that region and the enormous afflux of curiosity-seekers and "experts" right from the first hours after the sighting, the marks, or at any rate certain of them, could inadvertently have suffered changes before the investigators arrived."

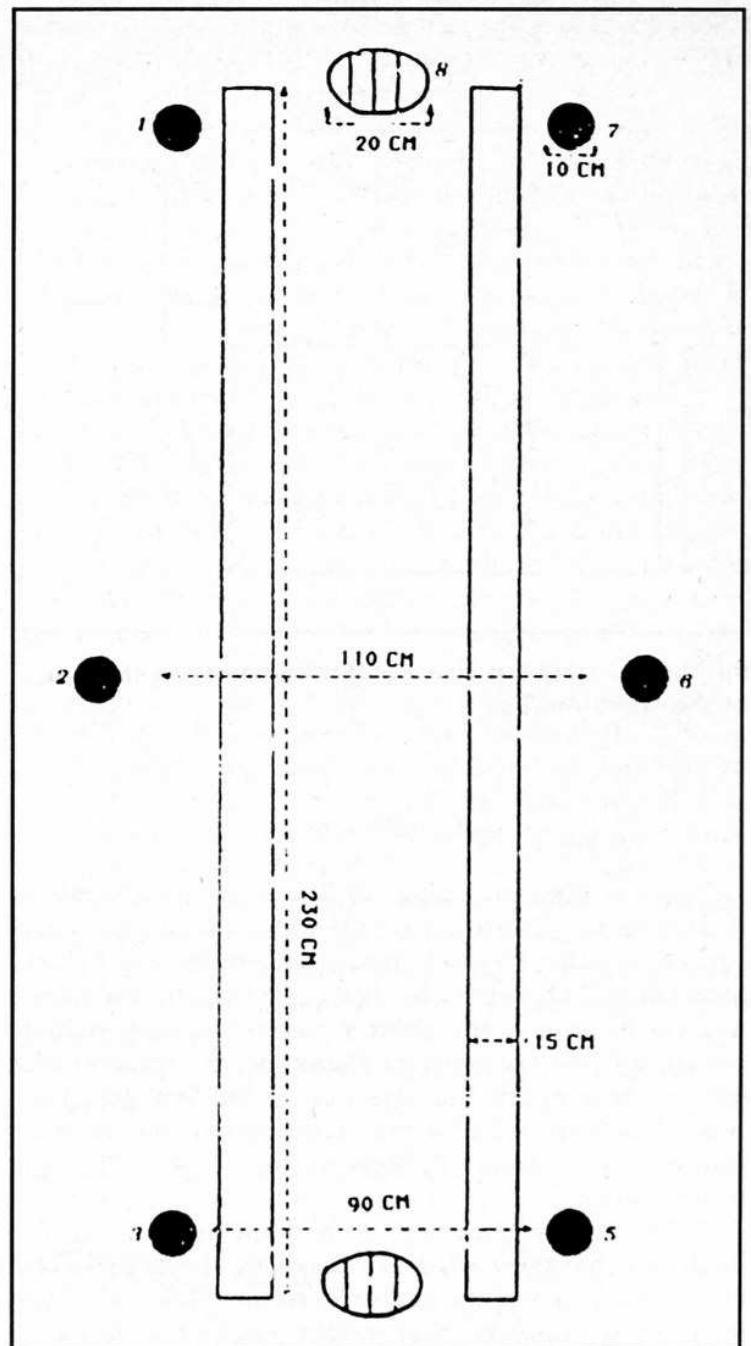

Fig. 8. The ground-marks left by the UFO (sketch by SOLARIS Research Group).

The two first types of mark, listed above under 1) and 2) and which are the only ones to present clear-cut depressions, yield a total support surface for the UFO of $(2 \times 191) + (6 \times 63.5) = 763$ cms².

The resistance of the soil to pressure was measured with a penetrometer. This instrument indicated a resistance (at the time when tested) of 1,25 kg./cm².

Applying the formula F (force-weight) = R (resistance of the soil) \times S (support surface), we obtain a pressure exercised on the soil by the UFO equal to $1.25 \times 763 = 953.75$ kgs.

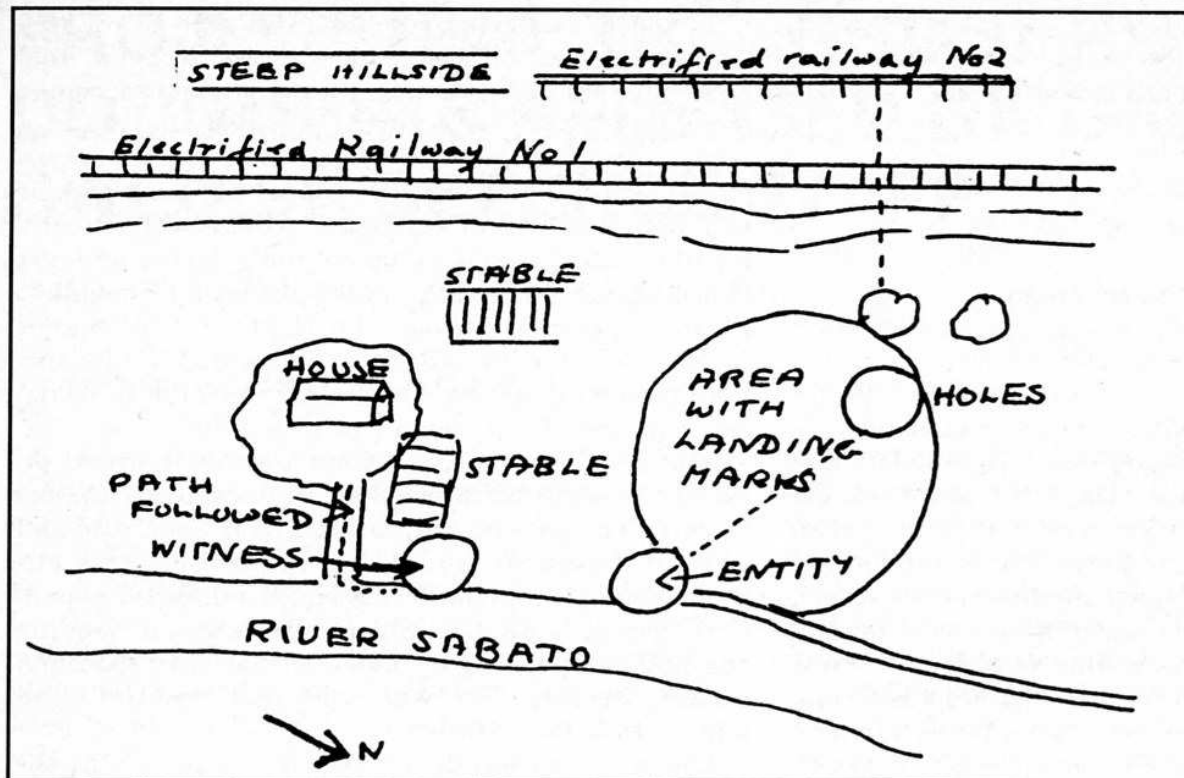

Fig. 9. General sketch of landing site. (Sketch by Solaris Research Group.)

Given the foregoing data, it will be noted that:—

- 1) The pressure exercised on the soil by the UFO would correspond to the real weight of that structure if the following conditions were met:
 - (A) The amount of movement of the UFO must have a value equal to or near to zero.
 - (B) The degree of humidity of the soil must remain constant during the two days following the event, since any variation would modify the degree of the resistance of the soil to deformation.
 - (C) The depth of the marks would have to be of only one centimetre.
- 2) The depth of the marks depends upon the speed at which the structure touches the ground (over and above its real weight and the degree of resistance of the soil). In the present case, examination of the marks permits us to affirm that they were produced by a body travelling at a speed very close to zero. In fact, were the contrary the case, the bulk of the marks would be at a deeper level than the surface-level of the terrain, which did not undergo pressure. This signified therefore that the pressure exercised on the soil by the UFO is in the vicinity of (in excess of) the real weight of the UFO itself.

- 3) Half of the pressure exercised on the soil by the UFO was on the surface of the two oval marks and half upon the total surface of the six cylindrical marks.
- 4) The fact that the marks are all of the same depth (9 cms.) suggests that the UFO landed from a position almost completely parallel to the surface of the ground.
- 5) The clear profile of the marks shows that the pressure which caused them was exercised from above downwards, perpendicularly to the surface of the ground.
- 6) The slight asymmetries observed in the disposition of the conico-cylindrical marks might possibly be explained — this is merely a hypothesis — by the fact that the supports were disposed in this fashion intentionally* (prior to the landing) in order to compensate for the asperities of the soil beneath. The undulating conformation of this perimeter (recorded by the investigators) confirms this hypothesis.

Temperature of the Soil

At 5.00 p.m. on October 8, 1984, measurements were taken of the temperatures inside and outside of the conico-cylindrical holes. This was carried out simultaneously, with two alcohol thermometers. The same test was repeated, under the same circumstances, at

4.00 p.m. on October 13, 1984.

The results obtained were:—

8/10/84 external temperature: 16.5 °C

8/10/84 internal temperature 18.5 °C

13/10/84 external temperature: 19.00 °C

13/10/84 internal temperature: 18.00 °C

Opinion of the Investigator

The abnormal increase in temperature inside the marks (measured at 5.00 p.m. on October 10, 1984, 57 hours after the UFO incident) could be explained — this is, of course, only a hypothesis — by the fact that the terrain situated beneath the UFO had been exposed to a certain type of energy of which a small amount still remained there in the soil in the form of infra-red rays. Three days after the first measurement, the temperature had descended again to a normal level (colder than the temperature outside the holes), which would seem to confirm the hypothesis as formulated above. This shows, in fact, that what we are here concerned with was indeed a transitory phenomenon that cannot be attributed to meteorological or geological causes.

Analyses of the Soil Samples

The purpose of the analyses made was to determine whether there might be any possible differences in the composition of the soil samples from the inside and from outside of the trace-holes. The spectrophotometric analysis was done with a Perkin-Elmer machine. In addition, a nuclear magnetic resonance analysis was also done, which revealed no traces of any type of protons.

Dr Corrado Malanga, of the University of Pisa, who conducted these measurements, concluded that “the analysis performed shows that the soil samples are perfectly comparable, within the limits of relative error of less than 5%, and display no bands indicating the presence of organic compounds; only mineral compounds are present”.

The pH measurements on all the samples gave a value of 5.5.

Note by Jacques Scornaux of L.D.L.N.

Complementary information extracted from the Report by the “Solaris” Research Centre, Naples.

As the independent investigations conducted by the Italian National UFO Research Centre (CUN) and by the “Solaris” Research Centre in Naples are largely in complete agreement, it would be tedious to reproduce both these reports *in extenso*. Apart from certain precise details about the trace-marks, we have extracted the few undermentioned items of additional information from the “Solaris” Centre’s report:—

As the “Solaris” investigation was the first one in

time, their representatives were still able to observe the state of fear in which the witness and his wife were. Signora Coccozza told them that she had come home and found her husband terrified, and both of them made it clear that they had never before seen a phenomenon of this sort. She added that some of their neighbours had said that, if the Coccozzas weren’t careful, the entity would come to their house and get them! She was thereupon plunged into a tremendous panic, especially during the nights. And Signor Coccozza told the investigators: “I’m scared lest he may have photographed me. I wouldn’t want him to recognize my face and come and carry me off!”

And at this point may I emphasise the harmful influence that can be inflicted on ill-informed witnesses by folk like this who only see the most simplistic and alarmist aspects of the UFO problem. And, as a further sociological detail of interest, I might here mention that, according to Signor Coccozza, the landing site has been visited by not less than one thousand curiosity-seekers. (So, who said that the UFOs no longer draw the crowds!)

One more curious detail, likewise mentioned by the witness, is that, after the Carabinieri, certain “experts” came from Naples and from Rome, with apparatus and instruments (for taking recordings, presumably) of kinds unknown to Signor Coccozza, which they introduced into the trace-holes. When they departed, he says they said that the trace-marks “*were the same as in other cases...*”

As regards the immediate environment, the Solaris report states that the Naples-Benevento railway-line passes at a distance of some 80 metres from Signor Coccozza’s house, and that three power-lines are just a few hundred metres distant.

The neighbourhood has a number of natural springs. There are few inhabitants in the area, and the site of the happenings is some hundreds of metres distant from the village and separated from it by sloping wooded terrains.

The UFO event caused no sensation, and has left no residue or after-effects. Signor Coccozza’s animals, fowls, rabbits, turkeys, geese, cattle, cats, and dogs (even one very aggressive watch-dog) all displayed no reactions.

Despite the fact that there are no other witnesses but Signor Coccozza, the “Solaris” UFO Research Centre in Naples are inclined, as are the investigators of the Italian National Centre, CUN, to favour the hypothesis that a close encounter of the third kind did genuinely occur at this spot.

Footnote

*For the discussion of precisely such a hypothetical type of retractable and adjustable landing-gear, see *The Landing at Socorro*, by W.T. Powers, in *THE HUMANOIDS*, edited by Charles Bowen (1969). — Editor, FSR

PROJECT 1946: THE "GHOST ROCKET" DOCUMENTS RELEASED BY THE SWEDISH DEFENCE STAFF

Anders Liljegren, FSR Consultant

Archives For UFO Research (AFU), P.O. Box 11027, S-600 11 Norrköping, Sweden

ALMOST exactly one year after the end of World War II a series of remarkable reports concerning unexplained aerial phenomena started to pour in to Swedish editorial offices and to the Defence Staff. During the May-December period of 1946 the Swedish defence headquarters received, according to official statistics, 997 such reports, but that figure is an underrating of the real number of sighting reports from Sweden and the Scandinavian countries during that year.

In about 100 incidents rocket-shaped objects — or luminous phenomena — were seen as they crashed towards the earth's surface. In many instances it seemed as if the phenomena were remote-controlled to crash into lakes and other water surfaces. Despite lengthy and extensive searches of the bottoms of several lakes the defence forces did not succeed in securing any metal, or similar wreckage parts, which with certainty could point to any kind of rocket construction. These new experiences were in sharp contrast to the territorial violations of the immediately preceding war years, when concrete evidence was secured through numerous airplane wreckages and other heaps of metallic scrap in several places.¹

"The ghost rockets" (or "ghost bombs"), as the phenomenon was christened by the media,² has for 40 years been an area of interest to UFO researchers, private citizens who try to investigate and document sightings of unidentified flying objects (UFOs). Lacking the support of the direct documents and observation data from this era, the phenomenon has been an object of wild speculation in books and magazines, not the least in the USA.

These writings have, of course, their background in a natural interest in what *really* happened over Sweden and Scandinavia in 1946. During 1947 reports of so-called "flying saucers" created an enormous sensation in the American press and finally forced the U.S. Air Force to start a more than 20 years long series of investigation projects. A search through 140 American newspapers has since revealed that the American sighting wave of 1947 had greater proportions than what was generally believed. For the summer months of June and July, alone, there are more than 850 sightings on file in American archives.³

There was a striking resemblance with the Swedish

phenomena a year before, although the two sighting waves described objects of completely different shapes. In both waves thousands of unprepared witnesses saw objects which neither they, nor their governments, could explain sufficiently. In Sweden, as well as in the United States, interest was primarily focussed on the Soviet Union, which was believed to be responsible for the strange occurrences. *Wild speculations on spaceships from other worlds were almost non-existent in those years (1946-48)*. Such theories were introduced during the summer of 1948 within the U.S. Air Force Project Sign and in the public media during 1949/50 through magazine articles and a book by aviation journalist *Donald E. Keyhoe*.

Swedish UFO researchers, who have attempted to locate the primary material from 1946, have been frustrated by statements from the Research Institute of National Defence and the Defence Staff that the documents were "lost" in the bureaucracy.⁴

Strong circumstantial evidence of secret documents

In 1976, thirty years after the incidents, an American researcher succeeded in finding some very interesting documents in the library of the Smithsonian Institution's National Air & Space Museum. Aviation and UFO historian *Don Berliner* was writing an article on the Swedish ghost rockets and made contact with the Museum to check their archives. Two important documents were found: one from the British Air Force Intelligence, the other from the Swedish Defence Staff...⁵

The British document, of five folio pages, is a detailed compilation and analysis of what British Intelligence had learned from Norway and Sweden. The SECRET British document takes a rather sceptical position regarding the phenomena. It was duplicated in at least 150 copies and distributed to British and American defence organisations. The distribution list points to a wide interest in the Swedish incidents. As early as 1958 the SECRET classification was cancelled by the U.S. Air Force, and the document ended up in the Smithsonian's open archives, where it probably remained for many years.⁶

Although the British report is interesting, *the Swedish document* is far more significant. It details the Swedish defence forces' own, direct experiences from